

Single Turn Wire Wound Potentiometer, R.W-3

The most sought after product in Domestic and International market from PANKAJ, model R.W-3 marks its presence since over five decades. Offers best value for money in manual setting application.

Features

- ◆ Brass Nickel Plated Bush & Spindle
- ◆ Tin Plated Terminals
- ◆ High Grade Engineering Moulded Plastic Housing

Optional Features

- ◆ Anti Rotating Mounting Plate
- ◆ Various Shaft Lengths and Designs
- ◆ Shaft Locking Nut

Electrical Specifications

Resistance Range	25Ω to 25KΩ
Resistance Tolerance	±10% Standard, ±5% Special
Power Rating	1 Watt @ 40°C
End Resistance	0.2Ω or 0.02% which ever is greater
Elec. Angle of Rotation	265° ± 15°
Maximum Working Voltage	250VDC
Insulation Resistance	200MΩ @ 500VDC
Voltage Proof	750VAC for 1 Min. At Sea level
TCR of Resistance Wire	150 ppm/°C
Rotational Life Expectancy	20,000 Cycles at 15 RPM
Temperature Range	0 - 70°C.



Mechanical Specifications

Housing Diameter	24mm
Housing Length	16mm
Shaft Diameter	6.3mm
Shaft Length	19mm or 25mm Standard
Bush Mounting	3/8" x 32 TPI, 10mm long
Mechanical Angle of Rot.	285° ± 15°

Applications

- ◆ Temperature Controllers
- ◆ Power Supplies, AC/DC Motor Drives
- ◆ Process Control Equipments
- ◆ Test and Measuring Instruments
- ◆ Control Panels
- ◆ Offset Settings & many more.

Single Turn Wire Wound Potentiometer, R.W-3

Product Images



Dimensional Diagram

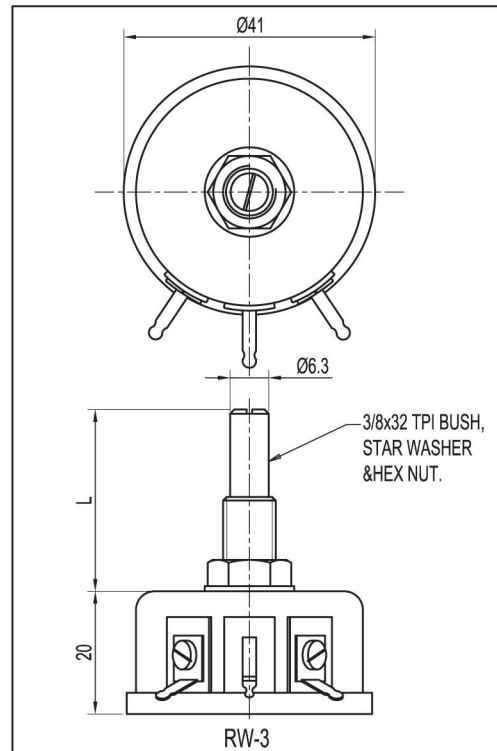

Ordering Information

Example: R.W-3, 10K, 25mm

Model No.	Resistance Value	Shaft Length in mm	Other Options
R. W-3	25, 50, 100, 150, 200, 250, 500, 1K, 2K, 2K5, 3K, 5K, 10K, 20K, 25K	Standard: 19mm or 25mm Other shaft length: 12.7mm, 16mm, 16 Flat, 19Flat	F - Flattened Shaft P - Locking Plate L - Shaft Locking Nut